

Installazione a parete / Wall Bracket Installation Steps for Concrete/Brick

- 1** Selezionate l'altezza desiderata. Utilizzate la staffa da muro come sagoma per segnare con una matita i punti da perforare con il trapano (x4). Controllate con una bolla (non inclusa) il corretto allineamento.

Select desired height. Use Wall Bracket as template to mark drilling locations with pencil (x4). Use level (not included) to ensure proper alignment.

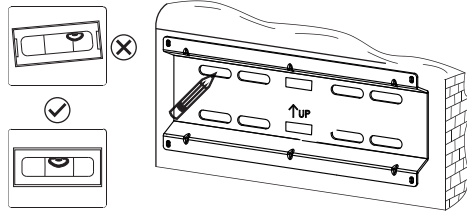

- 2** Praticate i fori guida in corrispondenza dei punti segnati (x4).
Drill pilot holes at marked locations (x4).

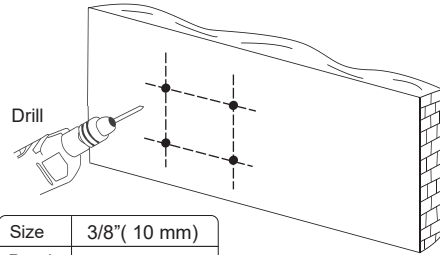

- 3** Con un martello inserite delicatamente i tasselli nei fori guida (x4).
Gently hammer Wall Anchors into pilot holes (x4).

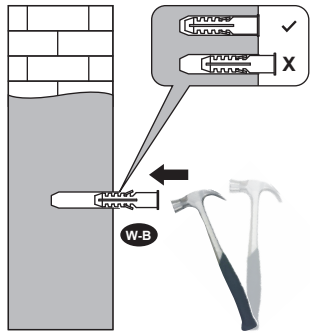

- 4** Fissate la staffa da muro con le viti (W-A).
Secure Wall Bracket with W-A.

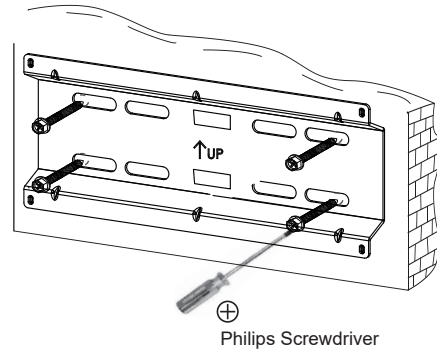

Appendere il TV sulla staffa a parete / Lift to hang Flat Screen onto Wall bracket

- 1** Sollevare e agganciare lo schermo piatto attaccando la staffa (A) alla staffa da muro (B).
Lift and hook flat screen with attached bracket (A) to the wall Bracket (B).

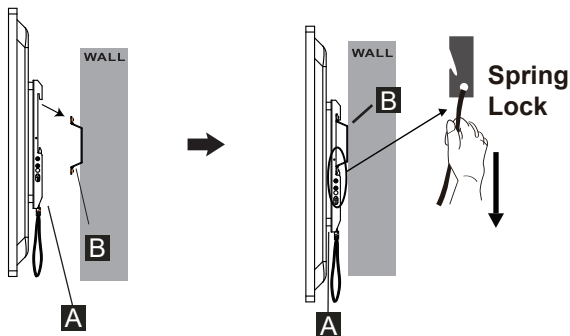

KARMA®

VD 124 - VD 157 Supporto TV



Manuale di istruzioni
Instruction manual

I E

Componenti della confezione / Component Checklist

A Staffa a parete x1 / Wall Bracket x1

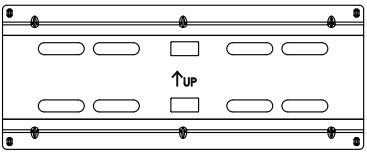

B Porta TV x2 / TV holder x2

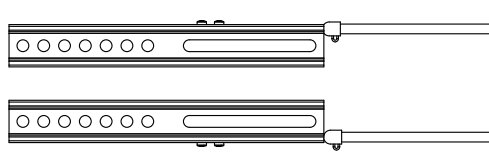

Kit Parete / Wall Kit

A. Ø10 Ø6 L50

B. ST6.3 x L50



Kit TV / Monitor Kit

C. M4 x 35

D. M6 x L35

E. M8 x L35

F. Ø13 Ø8 L20

For VD157 only

F. Ø6

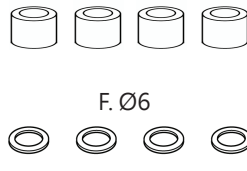
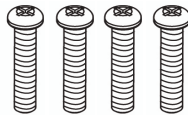
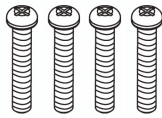
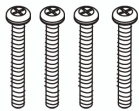

VD124



Max Screen Size
Dimensione TV



Max Screen Weight
Carico massimo

VD157



Max Screen Size
Dimensione TV



Max Screen Weight
Supporto massimo

Passaggi di collegamento con staffa schermo piatto / Flat Screen Bracket Attachment Steps

- 1 Allineate la staffa allo schermo piatto in base allo standard VESA dei fori (X4). Fissatela con le viti appropriate e le rondelle del kit monitor (come da illustrazione).

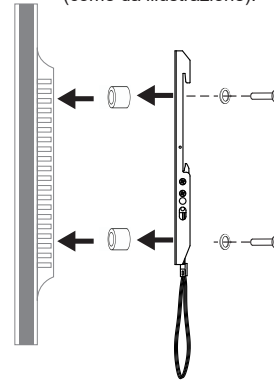

Align Flat Screen Bracket with VESA hole pattern on back of Flat Screen (X4). Secure with appropriate screw size and washers from Monitor Kit as illustrated.

Viti per TV / Screws from Monitor Kit

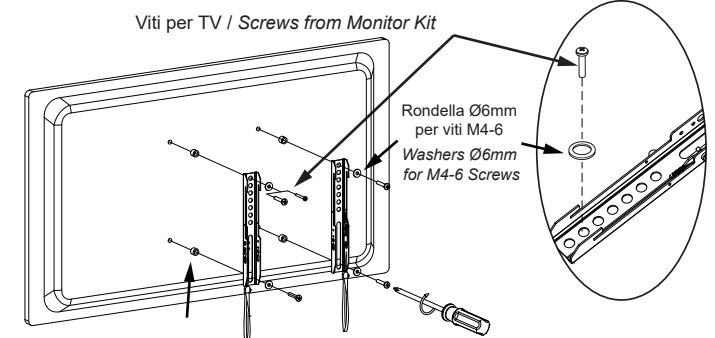

Usa i distanziali se necessario
Use the spacers if need

Installazione della staffa a parete in legno / Wall Bracket Installation Steps for Wood Studs

- 1 Individuate i montanti con un rivelatore. Segnate l'estremità e il centro del montante con una matita.

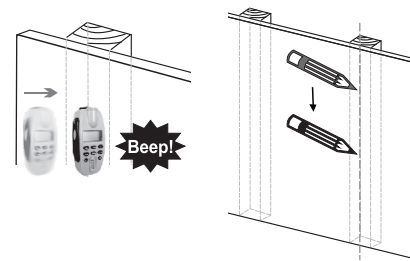

- 2 Selezionate l'altezza desiderata. Utilizzate la staffa da muro come sagoma per segnare con una matita i punti da perforare con il trapano (x4). Controllate con una bolla (non inclusa) il corretto allineamento.

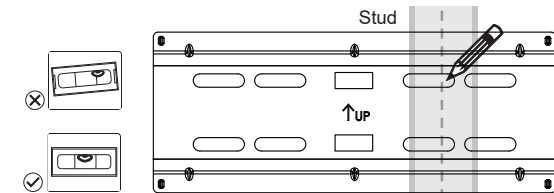

- 3 Praticate i fori guida in corrispondenza ai punti segnati (x4).

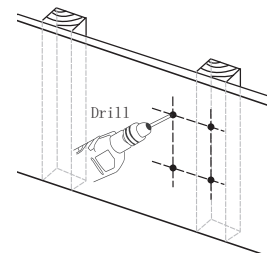

Drywall

Size	1/8"(3.2 mm)
Depth	penetrate

Stud

Size	1/8"(3.2 mm)
Depth	2 3/8"(60 mm)

- 4 Fissate la staffa da muro con le viti (W-A).

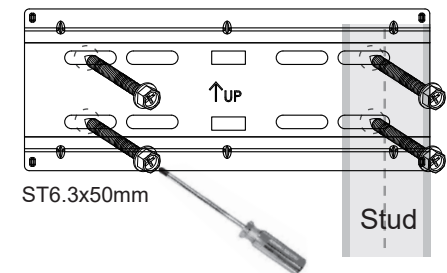

⊕ Philips Screwdriver